

TGD-A1 SERIES DIRECTIONAL COUPLER

P/N:TGD-A1203-06

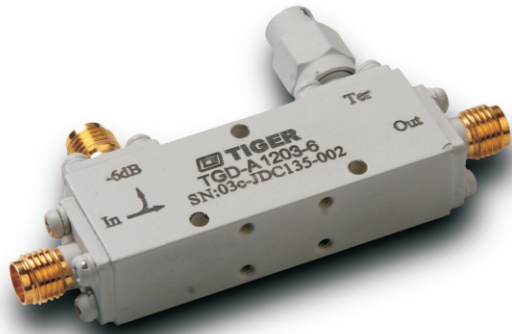

FEATURES AND APPLICATION:

TGD-A1 series directional coupler covers frequency 0.5-18GHz with SMA connector. Adopting strip line on circuit, it gets low insertion loss, high directivity and high power handling. The termination is interior located for using convenience.

TGD-A1203 broadband directional coupler mainly is used for radar, communication, satellite communication, navigation, measuring and testing fields, sampling and monitoring signal and splitting and combining uneven power. There are diverse coupling at choice.

The series is Tiger's standard product and can be customized according to customer's needs.

TECHNICAL SPECIFICATIONS:

Frequency Range	Insertion Loss	Coupling	VSWR	Directivity	Amplitude Balance
2-8GHz	0.5dB	6±1dB	1.2	20dB	± 1.0dB
Connector	Power Handling				
SMA-F	50W				

ENVIRONMENTAL PARAMETERS:

WORKING TEMPERATURE: -55~+85°C

STORAGE TEMPERATURE: -55~+100°C

OUTLINE: $\frac{\text{mm}}{\text{(inch)}}$

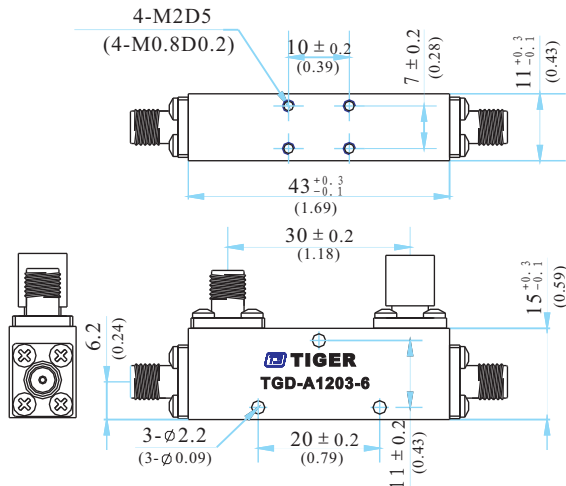

TYPICAL PLOT:

Coupling

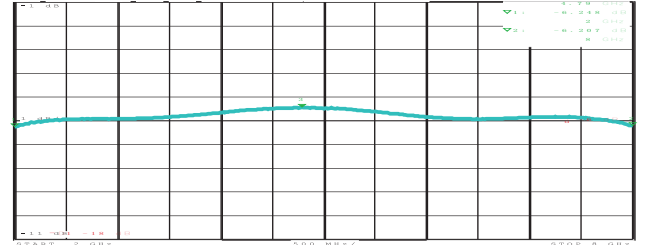

Isolation



Insertion loss

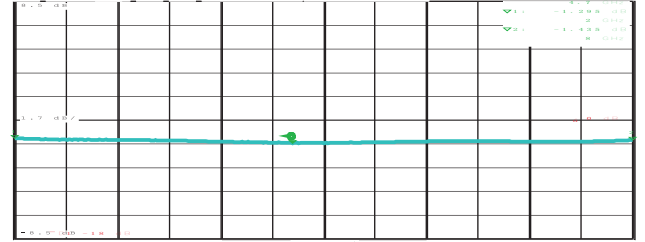

VSWR

