

TGD-B SERIES DIRECTIONAL COUPLER FOR COMMUNICATION

P/N:TGD-B1021-6



FEATURES AND APPLICATION:

TGD-B series directional coupler for communication adopts N-Female connector and strip line structure for circuit. It's with low insertion loss, high isolation, high power handling and inner termination for use convenience.

TGD-B series directional coupler is designed for wireless communication and mainly used for communication BTS and repeaters of GSM, CDMA and WCDMA bands.

The series is Tiger's standard products and can be customized according to customer's needs.

TECHNICAL SPECIFICATIONS:

Frequency Range	Insertion Loss	Coupling	VSWR	Directivity	Amplitude Balance
0.8-2.5GHz	0.5dB	6±0.5dB	1.25	20dB	± 0.7dB
Connector	Power Handling				
N-F	60W				

ENVIRONMENTAL PARAMETERS:

WORKING TEMPERATURE: -20~+70°C

STORAGE TEMPERATURE: -40~+70°C

OUTLINE: $\frac{\text{mm}}{\text{(inch)}}$

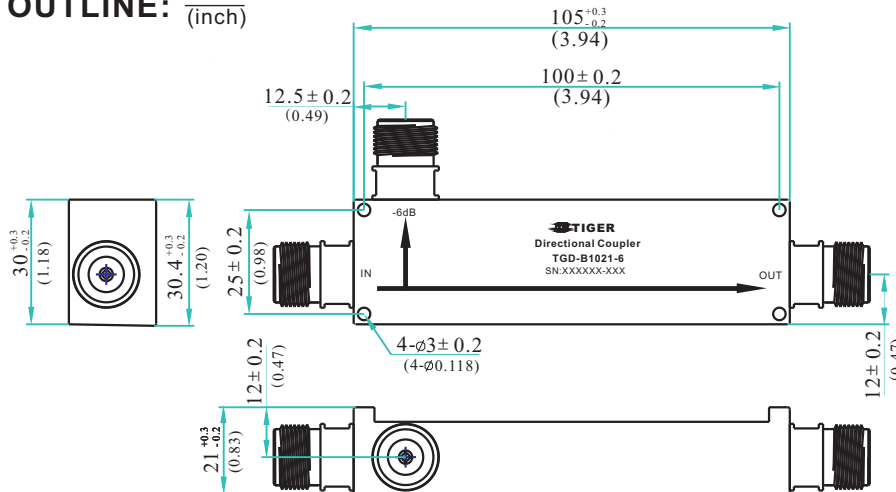

TYPICAL PLOT:

Coupling

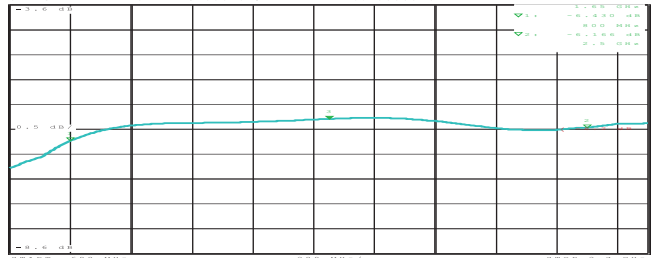

Isolation

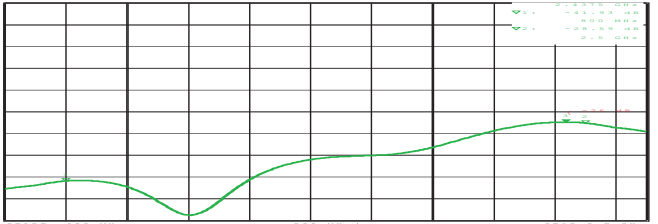

Insertion loss



VSWR

