

TGD-C SERIES DIRECTIONAL COUPLER FOR COMMUNICATION

P/N:TGD-C1025-10



FEATURES AND APPLICATION:

TGD-C series directional coupler for communication adopts N-Female connector and slab line structure for circuit. It's with low insertion loss, high directivity, high power handling and inner termination for use convenience.

TGD-C series directional coupler is designed for wireless communication and mainly used for communication BTS, repeaters of GSM, CDMA and WCDMA bands.

The series is Tiger's standard products and can be customized according to customer's needs.

TECHNICAL SPECIFICATIONS:

Frequency Range	Insertion Loss	Coupling	VSWR	Directivity	Frequency sensitivity
0.8-3.5GHz	0.4dB	10±0.8dB	1.25	20dB	± 0.7dB
Connector	Power Handling				
N-F	200W				

ENVIRONMENTAL PARAMETERS:

WORKING TEMPERATURE: -20~+70 °C

STORAGE TEMPERATURE: -40~+70 °C

OUTLINE: $\frac{\text{mm}}{\text{(inch)}}$

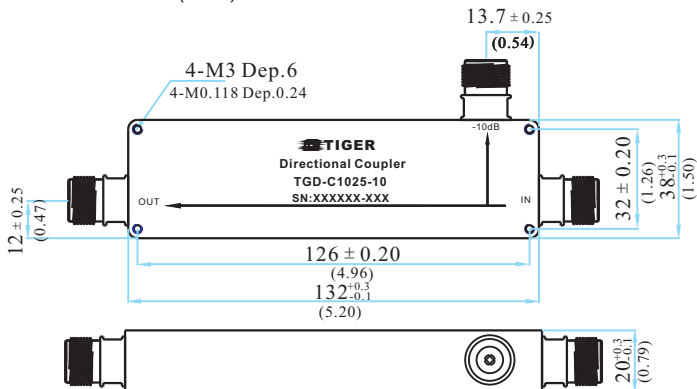

TYPICAL PLOT:

